



Version 1.0

# Leica Rugby 610

## Quick Start

- when it has to be **right**

*Leica*  
Geosystems



0/1

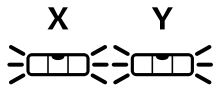

H.I. ALERT



+ 5 Hz =

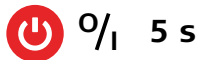

0/1 5 s

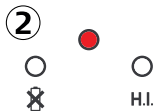
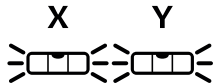
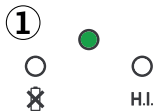

Battery (Li-Ion + Alkaline)

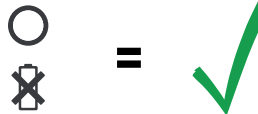

**Li-Ion**

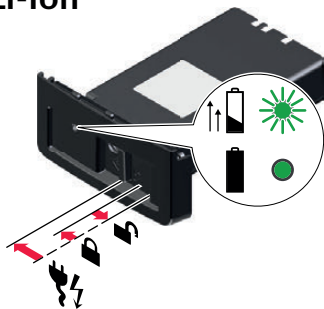

**Alkaline**  
4x D-cell (LR20)

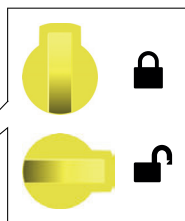
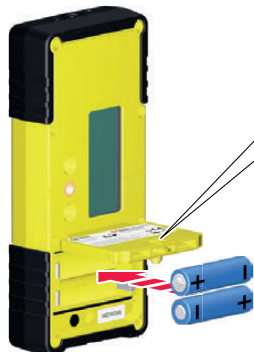
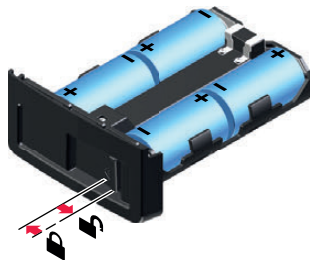

**Alkaline**  
2x AA-cell (LR6)

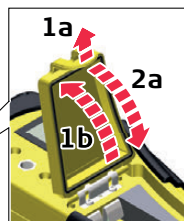

**Alkaline**  
9V Block

## Rod Eye 140, Classic



0/1



±1 mm, ±2 mm, ±3 mm



## Rod Eye Basic



0/1



±1 mm, ±3 mm



## Setting Forms

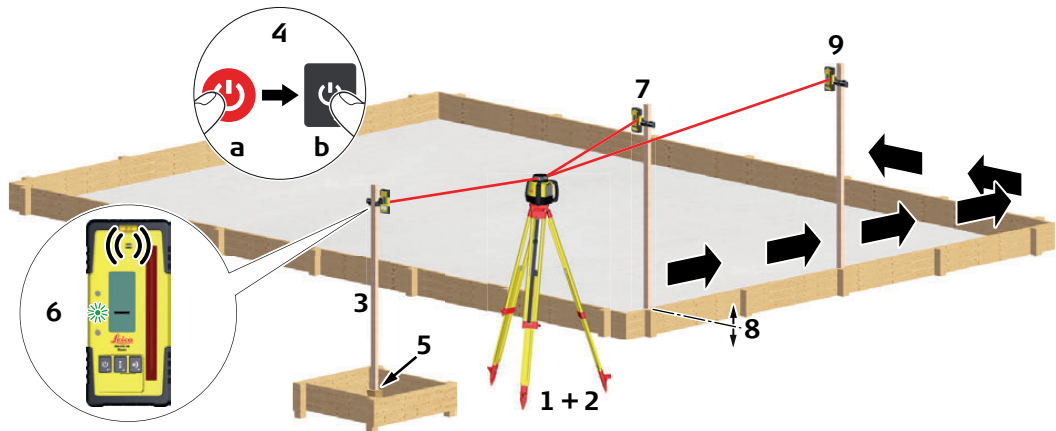

## Checking Grades

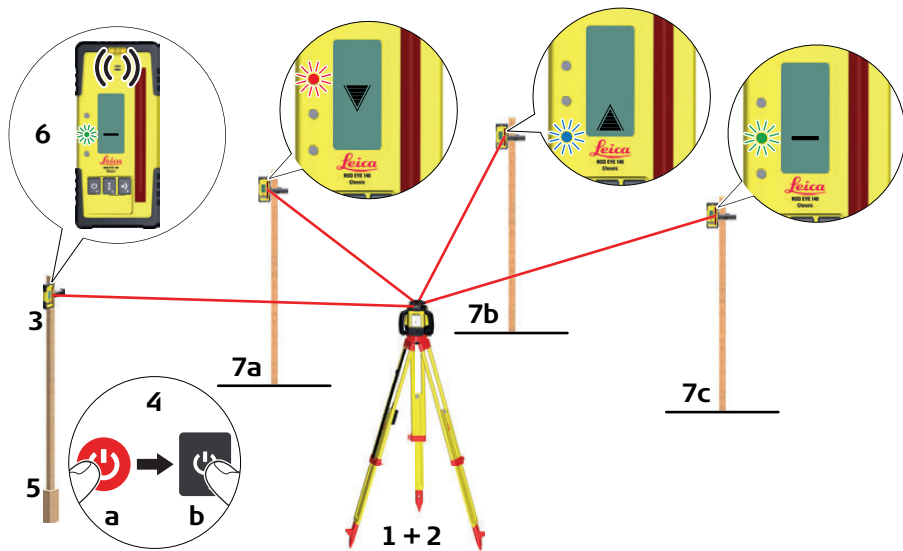

# Manual Grading

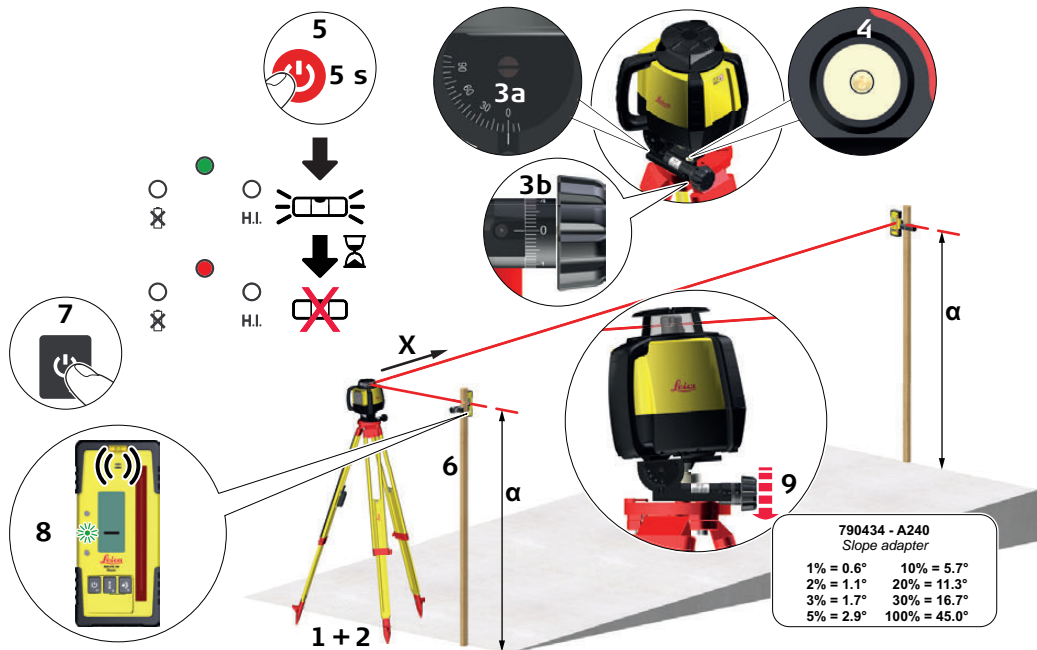

## Conformity to National Regulations

- FCC Part 15 (applicable in the US).



Hereby, Leica Geosystems AG, declares that the product/s is/are in compliance with the essential requirements and other relevant provisions of the applicable European Directives. The declaration of conformity can be consulted at <http://www.leica-geosystems.com/ce>.

---



Laser class 1 product  
in accordance with  
IEC 60825-1:2014

### Leica Geosystems AG

Heinrich-Wild-Strasse  
CH-9435 Heerbrugg  
Switzerland  
Phone +41 71 727 31 31

[www.leica-geosystems.com](http://www.leica-geosystems.com)

- when it has to be **right**

**Leica**  
Geosystems

**812959-2.0.0**

Original text  
© 2013 Leica Geosystems AG, Heerbrugg, Switzerland